

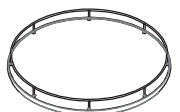

NO	PARÇA RESMI/ PART DRAWING	S-3053 S-3054 AD./PCS.
1		2
2		2
3		2
4		4
5		4
6		2
7		2
8		2
9	4x16 SUNTA VIDASI C.SCREW 4x12 YHB VIDASI C.SCREW	30 8